

MATERIAL TÉCNICO
PARA CHURRASQUEIRA
DE EMBUTIR A GÁS
(P.M.G)

Metal Flama
Lareiras e Churrasqueiras

DESCRIÇÃO CHURRASQUEIRA DE EMBUTIR A GÁS

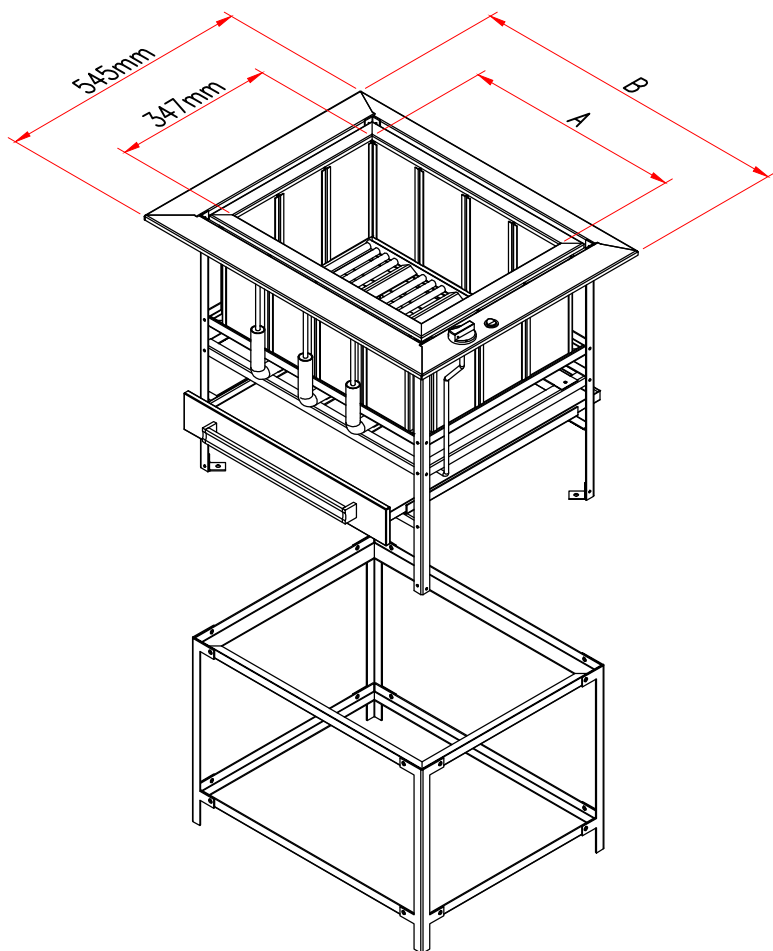

- MOLDURA SUPERIOR EM AÇO INOX
- BASE EM CANTONEIRA DE FERRO
- CAIXA DE QUEIMA EM AÇO CARBONO COM REFROTÁRIOS INTERNOS E REVESTIMENTO EXTERNO EM LÃ DE ROCHA.
- PINTURA ELETROSTÁTICA PRETA
- ACENDIMENTO ELÉTRICO

PADRÃO	A	B
PEQUENO	470mm	700mm
MÉDIO	580mm	810mm
GRANDE	690mm	920mm

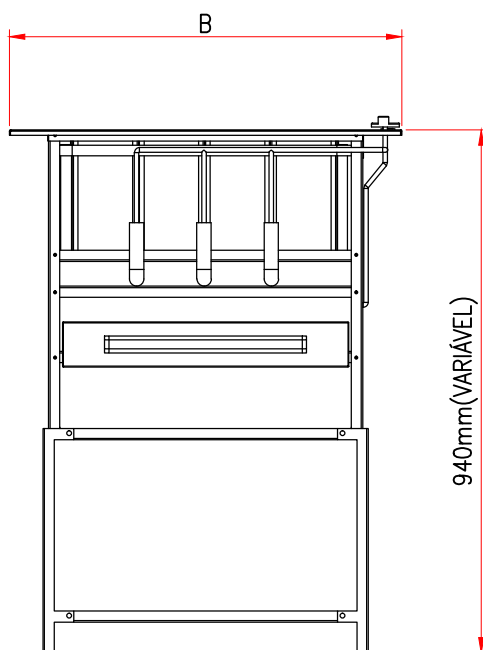

VISTA FRONTAL

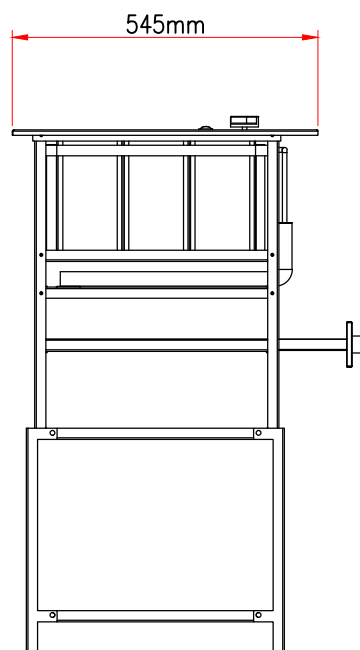

VISTA LATERAL

EXEMPLO DE CHURRASQUEIRA DE EMBUTIR A GÁS NO NICHU DE ALVENARIA COM CAVALETE.

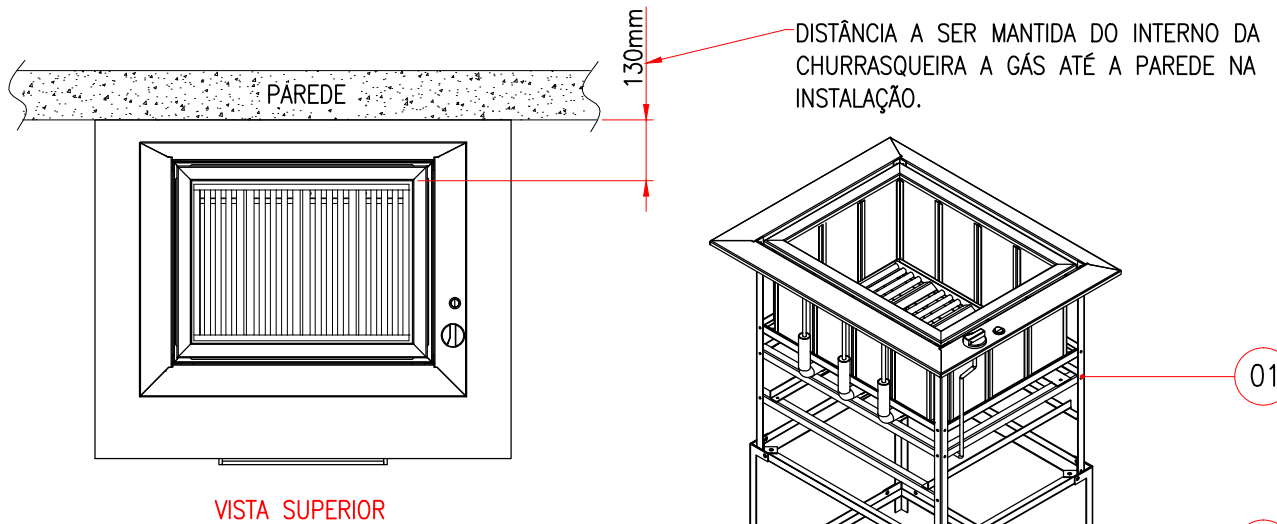
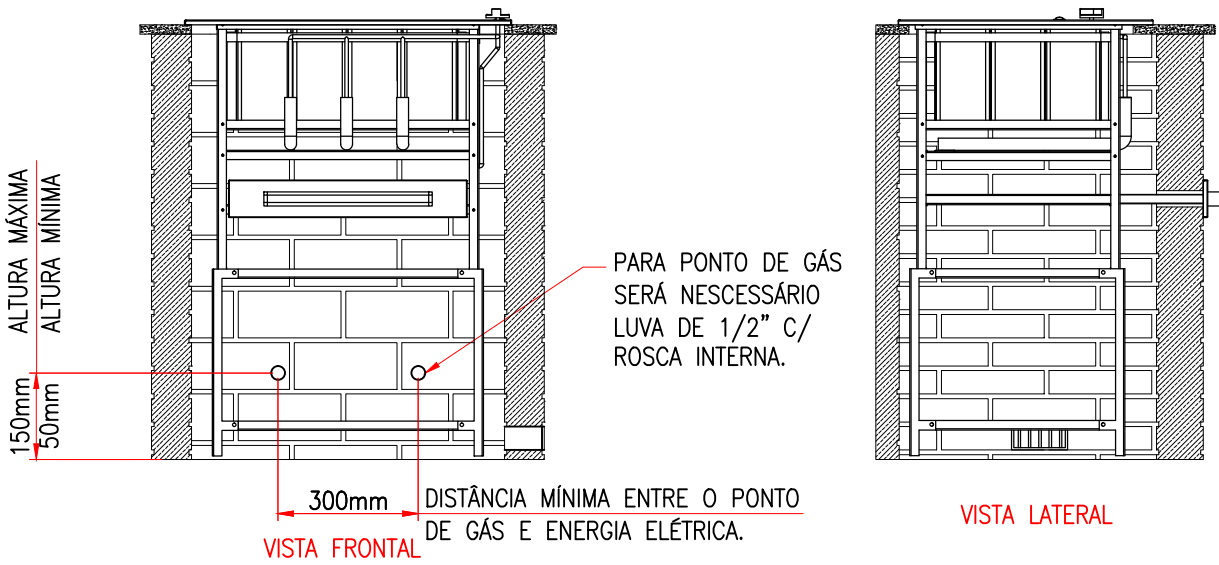

- 1- CHURRASQUEIRA DE EMBUTIR A GÁS.
- 2-CAVALETE.
- 3-NICHO DE ALVENARIA PARA CHURRASQUEIRA.
- 4-GAVETA DA CHURRASQUEIRA.

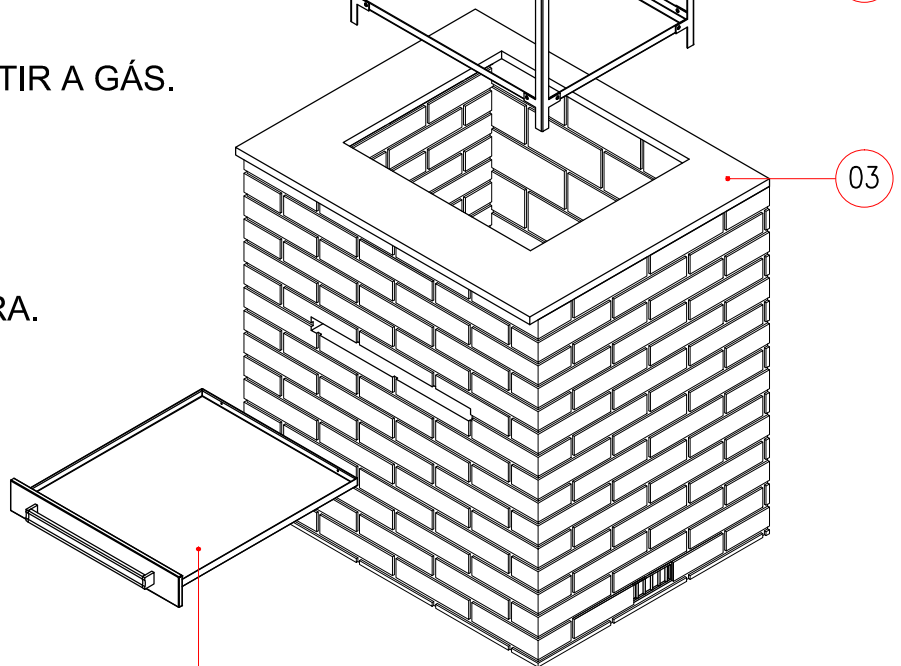

EXEMPLO DE CHURRASQUEIRA DE EMBUTIR A GÁS NO NICHU DE ALVENARIA COM LAJE.

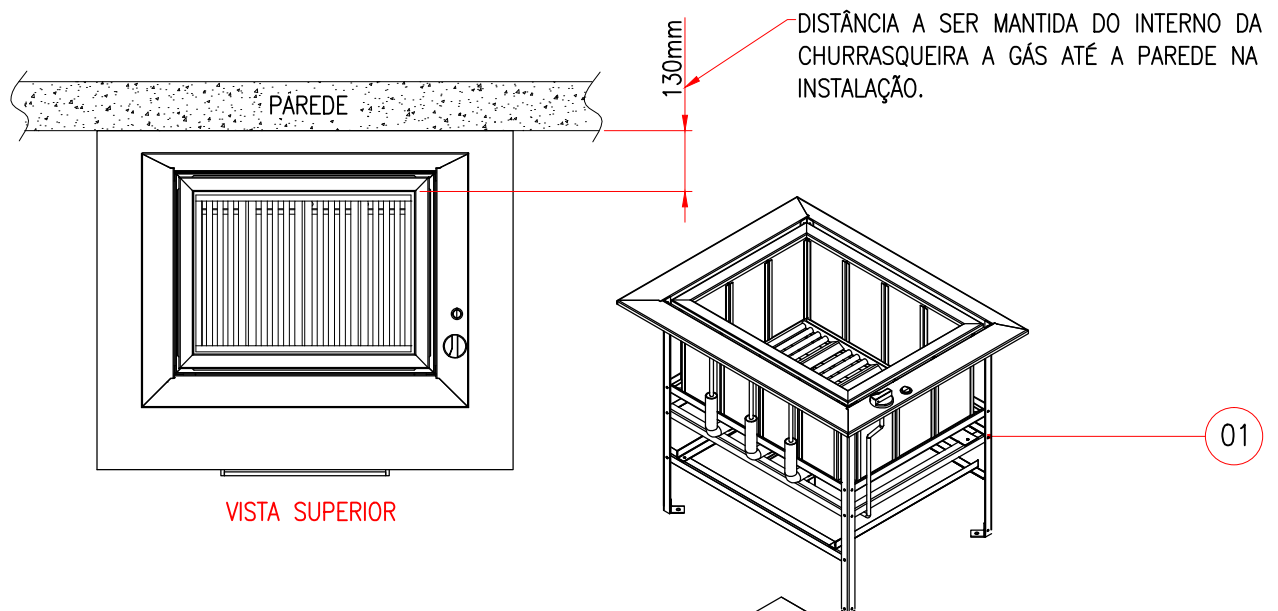
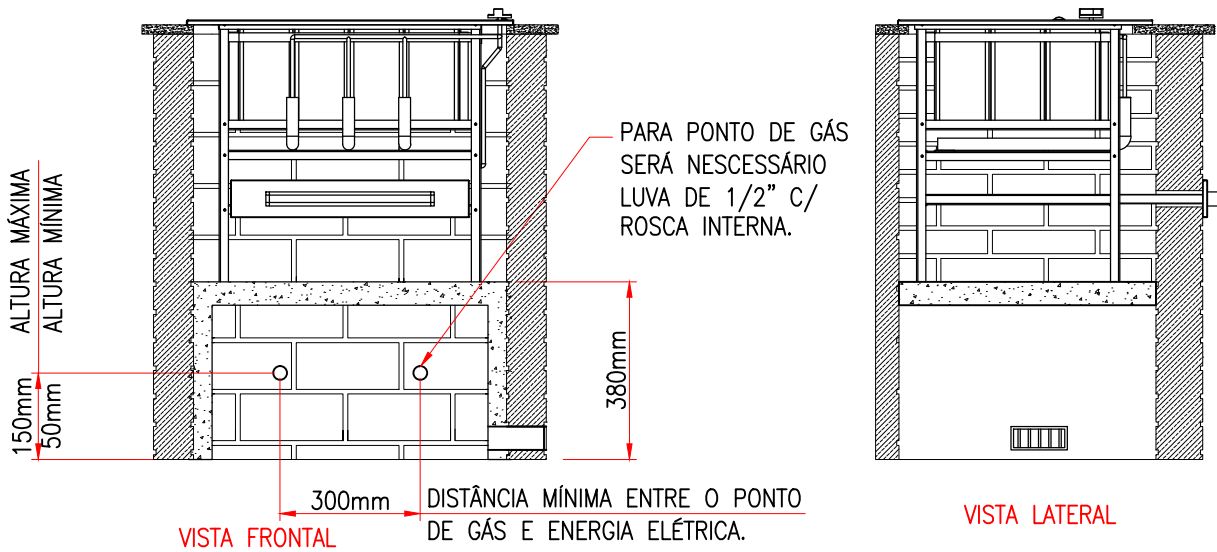

- 1- CHURRASQUEIRA DE EMBUTIR A GÁS.
- 2-NICHU DE ALVENARIA PARA CHURRASQUEIRA.
- 3-LAJE.
- 4-GAVETA DA CHURRASQUEIRA.

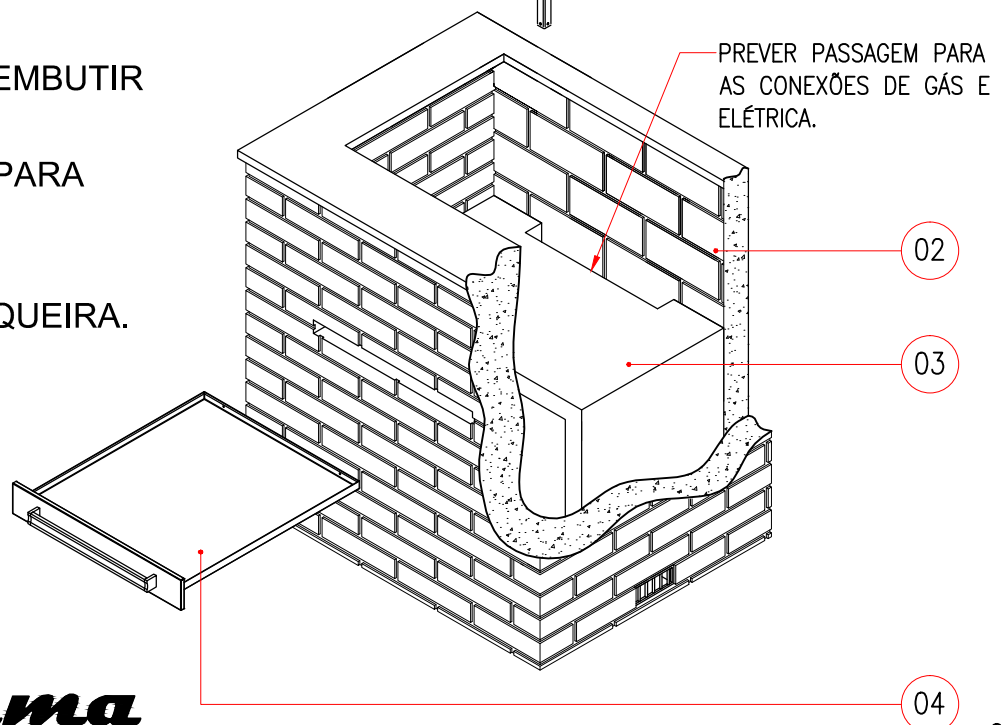

EXEMPLO DO NICHU DE ALVENARIA PARA CHURRASQUEIRA DE EMBUTIR A GÁS. (BANCADA 700mm)

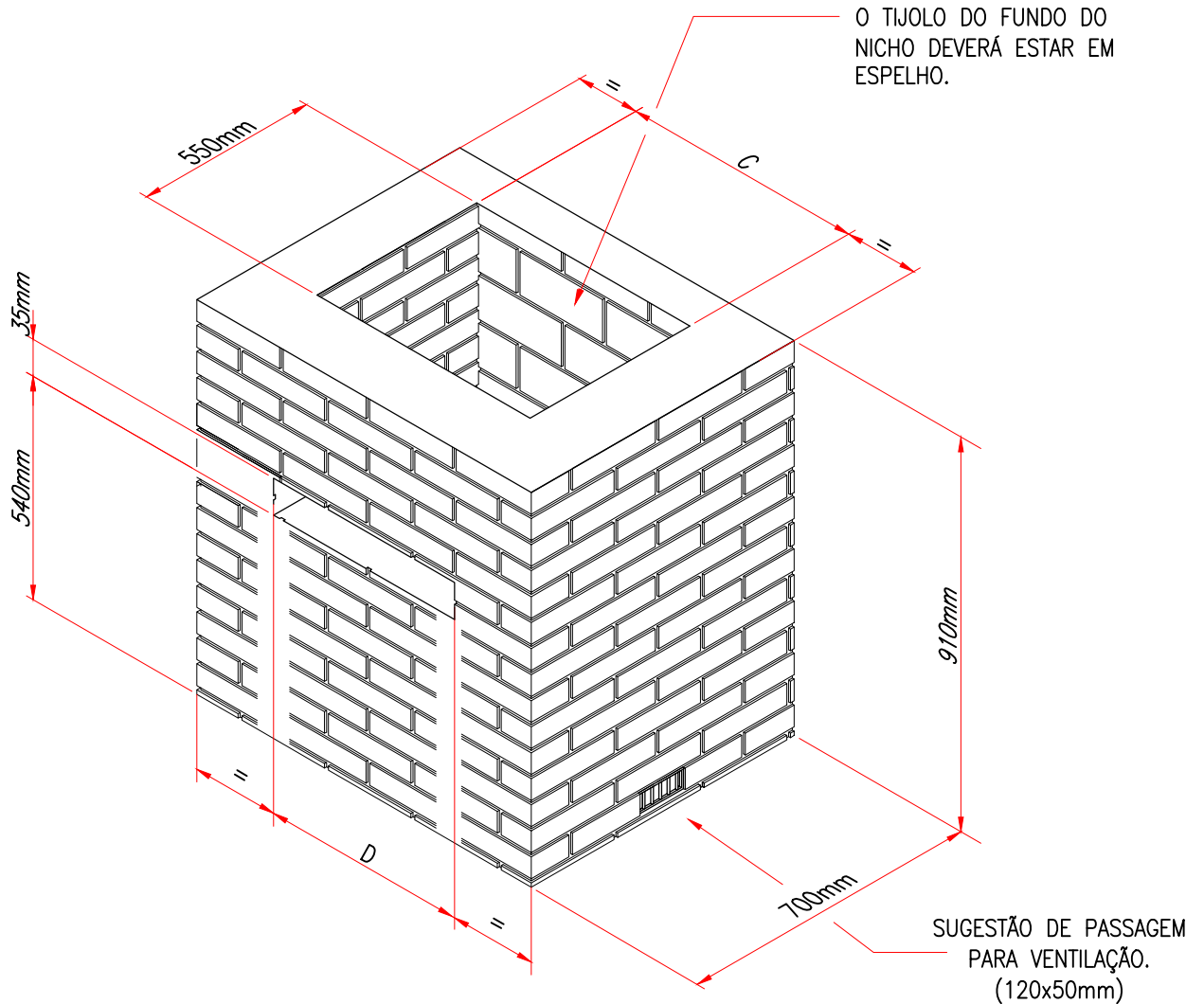

PADRÃO	C	D
PEQUENO	670mm	480mm
MÉDIO	780mm	575mm
GRANDE	890mm	675mm

EXEMPLO DO CORTE DA PEDRA PARA
CHURRASQUEIRA DE EMBUTIR A GÁS.

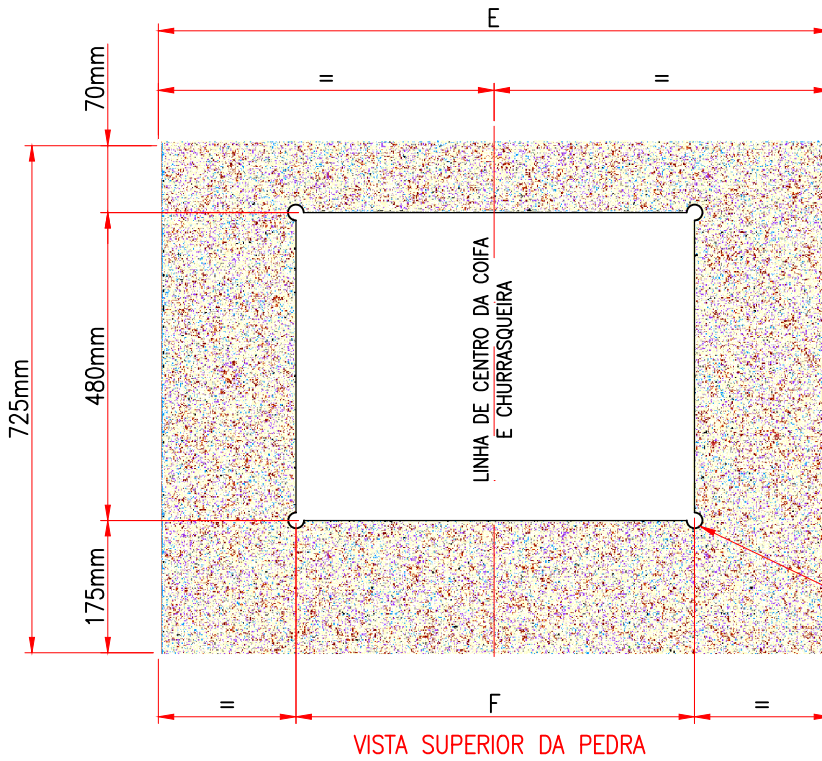

PADRÃO	E	F
PEQUENO	890mm	670mm
MÉDIO	1000mm	780mm
GRANDE	1110mm	890mm

ELIMINAR CANTOS VIVOS INTERNOS DA PEDRA COM SERRA COPO DE $\phi 1"$.

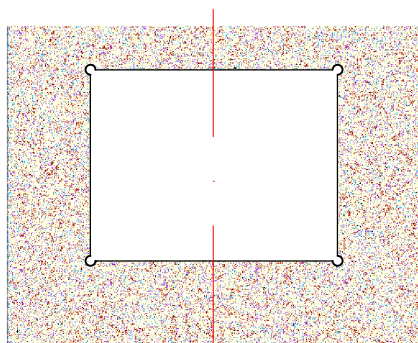
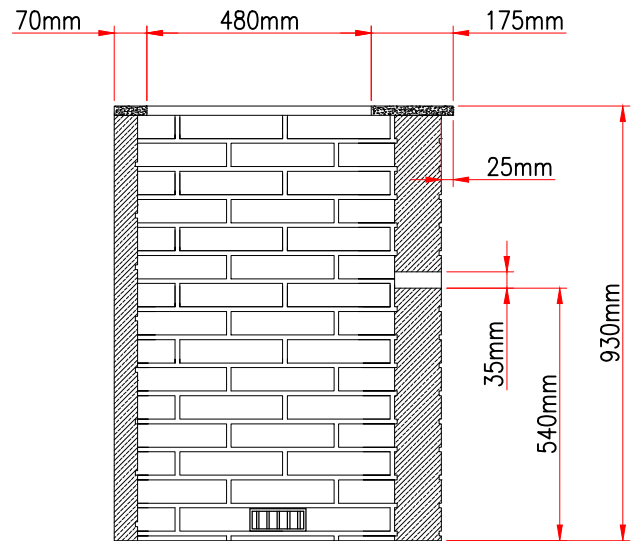
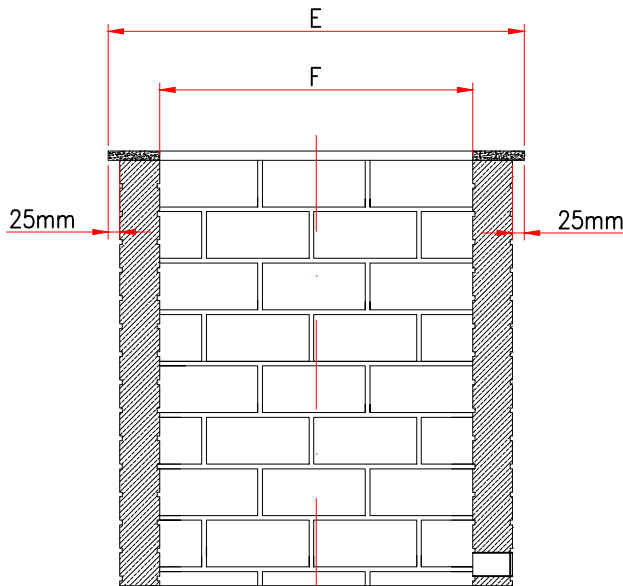

EXEMPLO DE INSTALAÇÃO DA
PEDRA NO NICHÓ

EXEMPLO DE CHURRASQUEIRA DE EMBUTIR A GÁS EM BALCÃO
 DE 600mm SEM ALVENARIA.
 (ACONSELHAVEL P/ MARCENARIA)

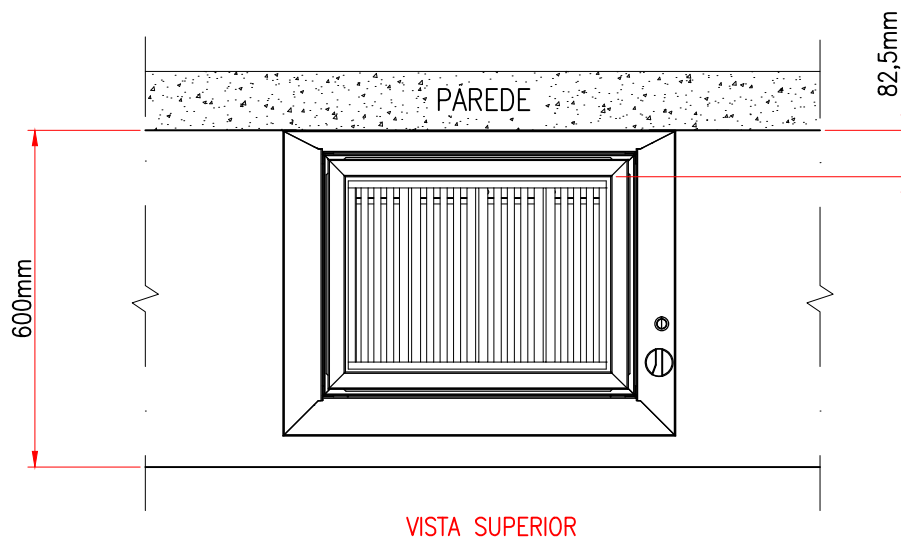

EXEMPLO DO CORTE DA PEDRA PARA CHURRASQUEIRA DE
 EMBUTIR A GÁS. (BALCÃO DE 600mm)

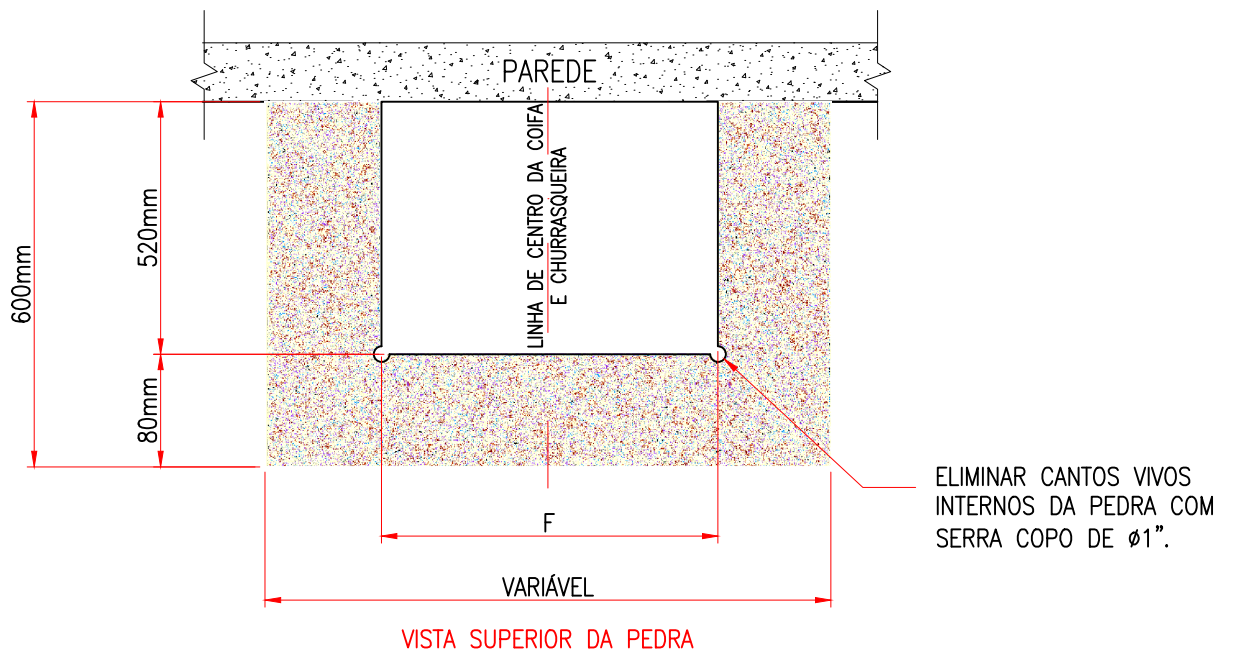

PADRÃO	F
PEQUENO	670mm
MÉDIO	780mm
GRANDE	890mm